



DECLARATION OF PERFORMANCE



No. 0012 – EN

1. Unique identification code of the product-type: **fischer injection system FIS EM**

2. Intended use/es:

Product	Intended use/es
Metal anchors for use in concrete (heavy-duty type)	For fixing and/or supporting concrete structural elements or heavy units such as cladding and suspended ceilings, see appendix, especially Annexes B 1 to B 10

3. Manufacturer: **fischerwerke GmbH & Co. KG, Otto-Hahn-Straße 15, 79211 Denzlingen, Germany**

4. Authorised representative: --

5. System/s of AVCP: **1**

6a. Harmonised standard: ---

Notified body/ies: ---

6b. European Assessment Document: **ETAG 001; 2013-04**

European Technical Assessment: **ETA-10/0012; 2015-03-19**

Technical Assessment Body: **DIBt**

Notified body/ies: **1343 – MPA Darmstadt**

7. Declared performance/s:

Mechanical resistance and stability (BWR 1)

Essential characteristic	Performance
Characteristic values under static and quasi-static action for design according to TR 029 or CEN/TS 1992-4:2009, Displacements	See appendix, especially Annexes C 1 to C 14
Characteristic resistance for seismic performance categories C1 and C2 for design according to Technical Report TR 045, Displacements	See appendix, especially Annexes C 15 to C 18

Safety in case of fire (BWR 2)

Essential characteristic	Performance
Reaction to fire	Anchorage satisfy requirements for Class A1
Resistance to fire	No performance determined (NPD)

8. Appropriate Technical Documentation and/or Specific Technical Documentation: ---

The performance of the product identified above is in conformity with the set of declared performance/s. This declaration of performance is issued, in accordance with Regulation (EU) No 305/2011, under the sole responsibility of the manufacturer identified above.

Signed for and on behalf of the manufacturer by:

Andreas Bucher, Dipl.-Ing.

Wolfgang Hengesbach, Dipl.-Ing., Dipl.-Wirtsch.-Ing.

Tumlingen, 2015-03-12

- This DoP has been prepared in different languages. In case there is a dispute on the interpretation the english version shall always prevail.

- The Appendix includes voluntary and complementary information in English language exceeding the (language-neutrally specified) legal requirements.

Specific Part

1 Technical description of the product

The fischer injection system FIS EM is a bonded anchor consisting of a cartridge with injection mortar fischer FIS EM and a steel element. The steel element consist of

- a commercial threaded rod with washer and hexagon nut of sizes M8 to M30 or
- a fischer internal threaded anchor RG MI of sizes M8 to M20 or
- a deformed reinforcing bar of sizes $\phi = 8$ to 40 mm or
- a fischer rebar anchor FRA of sizes M12 to M24

The steel element is placed into a drilled hole filled with injection mortar and is anchored via the bond between metal part, injection mortar and concrete.

The product description is given in Annex A.

2 Specification of the intended use in accordance with the applicable European Assessment Document

The performances given in Section 3 are only valid if the anchor is used in compliance with the specifications and conditions given in Annex B.

The verifications and assessment methods on which this European Technical Assessment is based lead to the assumption of a working life of the anchor of at least 50 years. The indications given on the working life cannot be interpreted as a guarantee given by the producer, but are to be regarded only as a means for choosing the right products in relation to the expected economically reasonable working life of the works.

3 Performance of the product and references to the methods used for its assessment

3.1 Mechanical resistance and stability (BWR 1)

Essential characteristic	Performance
Characteristic values under static and quasi-static action for design according to TR 029 or CEN/TS 1992-4:2009, Displacements	See Annex C 1 to C 14
Characteristic values for seismic performance categories C1 and C2 for design according to Technical Report TR 045, Displacements	See Annex C 15 to C 18

3.2 Safety in case of fire (BWR 2)

Essential characteristic	Performance
Reaction to fire	Anchorage satisfy requirements for Class A1
Resistance to fire	No performance determined (NPD)

3.3 Hygiene, health and the environment (BWR 3)

Regarding dangerous substances there may be requirements (e.g. transposed European legislation and national laws, regulations and administrative provisions) applicable to the products falling within the scope of this European Technical Assessment. In order to meet the provisions of Regulation (EU) No 305/2011, these requirements need also to be complied with, when and where they apply.

3.4 Safety in use (BWR 4)

The essential characteristics regarding Safety in use are included under the Basic Works Requirement Mechanical resistance and stability.

3.5 Protection against noise (BWR 5)

Not applicable.

3.6 Energy economy and heat retention (BWR 6)

Not applicable.

3.7 Sustainable use of natural resources (BWR 7)

The sustainable use of natural resources was not investigated.

3.8 General aspects

The verification of durability is part of testing the essential characteristics. Durability is only ensured if the specifications of intended use according to Annex B are taken into account.

4 Assessment and verification of constancy of performance (AVCP) system applied, with reference to its legal base

According to Decision of the Commission of 24 June 1996 (96/582/EC) (OJ L 254 of 08.10.96 p. 62-65), the system of assessment and verification of constancy of performance (see Annex V and Article 65 Paragraph 2 to Regulation (EU) No 305/2011) given in the following table applies.

Product	Intended use	Level or class	System
Metal anchors for use in concrete (heavy-duty type)	For fixing and/or supporting concrete structural elements or heavy units such as cladding and suspended ceilings	—	1

Installation conditions

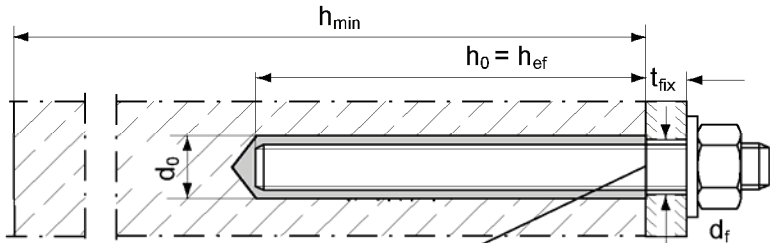

threaded rod
Pre-positioned anchorage

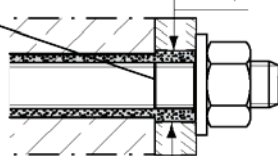

threaded rod
push-through anchorage
(annular gap filled with mortar)
Only injection mortar system

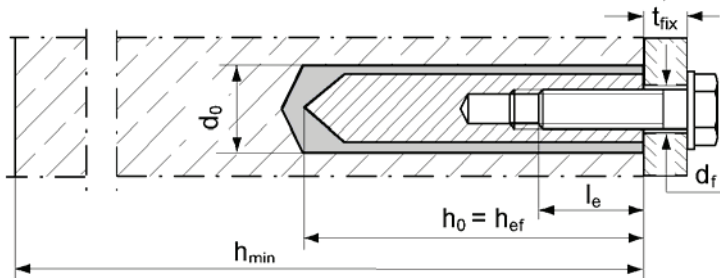

fischer internal threaded anchor RG MI
Only pre-positioned anchorage

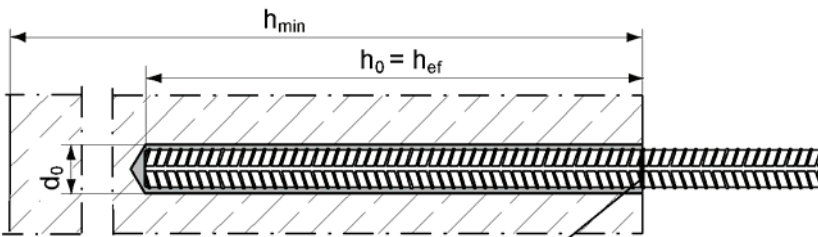

Reinforcing bar

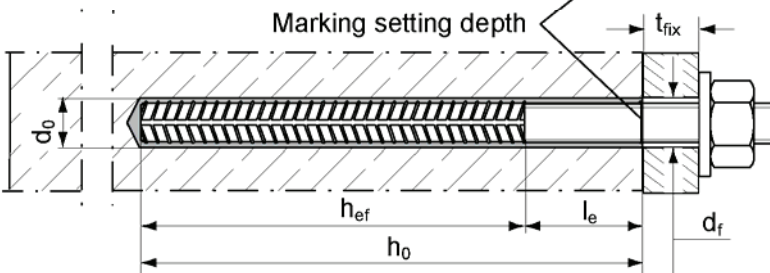

fischer rebar anchor FRA
Pre-positioned anchorage
Only injection mortar system

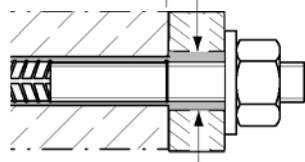

fischer rebar anchor FRA
push-through anchorage
(annular gap filled with mortar)
Only injection mortar system

fischer injection system FIS EM

Product description
Installation conditions

Annex A 1

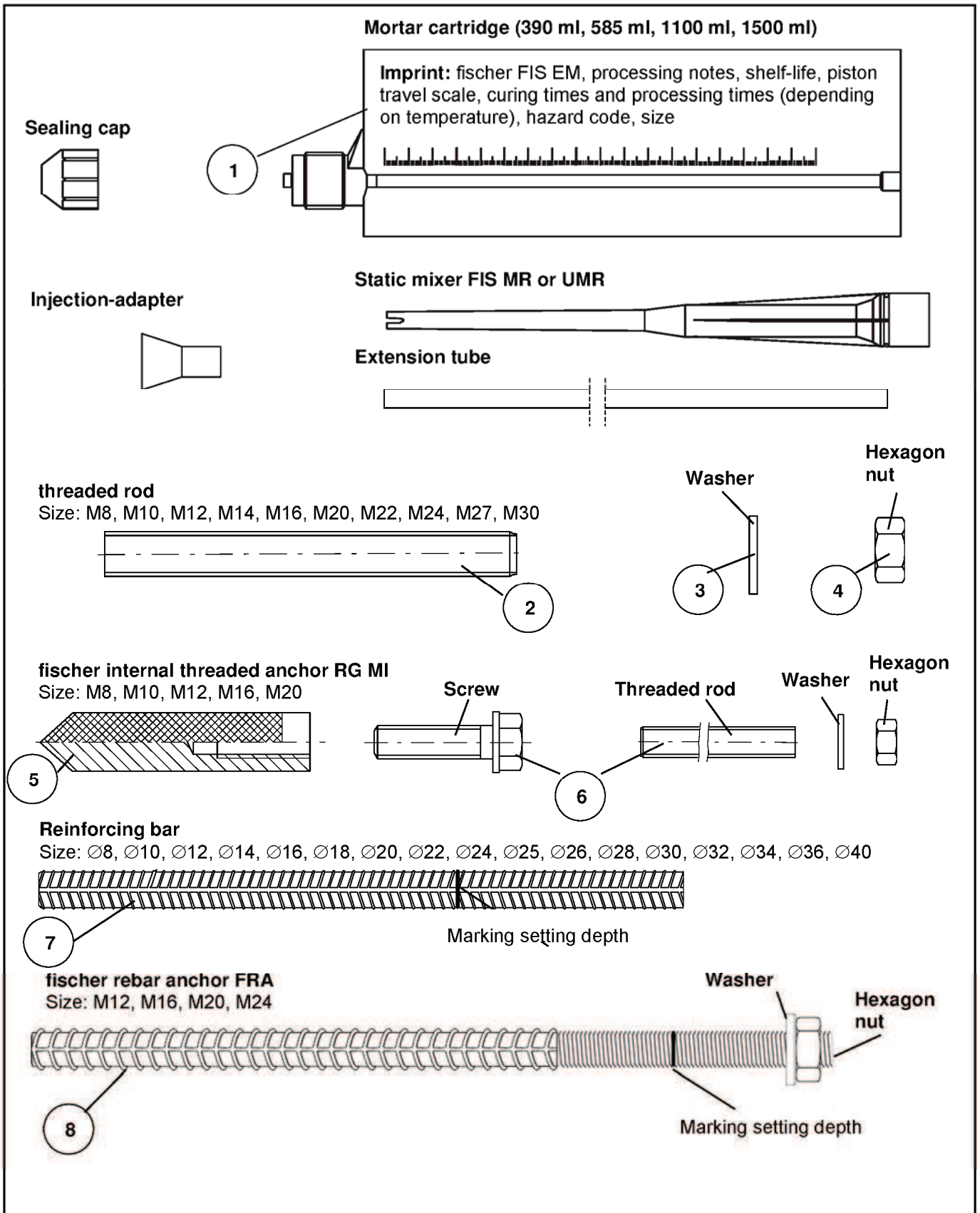

<p>fischer injection system FIS EM</p>	<p>Annex A 2</p>
<p>Product description Cartridges/Static mixer/ Steel elements</p>	

Table A1: Materials

Part	Designation	Material		
1	Mortar cartridge	Mortar, hardener, filler		
		Steel, zinc plated	Stainless steel A4	High corrosion-resistant steel C
2	Threaded rod	Property class 5.8 or 8.8; EN ISO 898-1: 2013 zinc plated $\geq 5\mu\text{m}$, EN ISO 4042:1999 A2K or hot-dip galvanised EN ISO 10684:2004 $f_{uk} \leq 1000 \text{ N/mm}^2$ $A_5 > 12\%$ fracture elongation	Property class 50, 70 or 80 EN ISO 3506:2009 1.4401; 1.4404; 1.4578; 1.4571; 1.4439; 1.4362; 1.4062 EN 10088-1:2014 $f_{uk} \leq 1000 \text{ N/mm}^2$ $A_5 > 12\%$ fracture elongation	Property class 50 or 80 EN ISO 3506:2009 or property class 70 with $f_{yk} = 560 \text{ N/mm}^2$ 1.4565; 1.4529 EN 10088-1:2014 $f_{uk} \leq 1000 \text{ N/mm}^2$ $A_5 > 12\%$ fracture elongation
3	Washer ISO 7089:2000	zinc plated $\geq 5\mu\text{m}$, EN ISO 4042:1999 A2K or hot-dip galvanised EN ISO 10684:2004	1.4401; 1.4404; 1.4578; 1.4571; 1.4439; 1.4362 EN 10088-1:2014	1.4565; 1.4529 EN 10088-1:2014
4	Hexagon nut	Property class 5 or 8; EN ISO 898-2:2013 zinc plated $\geq 5\mu\text{m}$, ISO 4042:1999 A2K or hot-dip galvanised EN ISO 10684:2004	Property class 50, 70 or 80 EN ISO 3506:2009 1.4401; 1.4404; 1.4578; 1.4571; 1.4571; 1.4439; 1.4362 EN 10088-1:2014	Property class 50, 70 or 80 EN ISO 3506:2009 1.4565; 1.4529 EN 10088-1:2014
5	fischer internal threaded anchor RG MI	Property class 5.8 or 8.8; ISO 898-1:2013 zinc plated $\geq 5\mu\text{m}$, ISO 4042:1999 A2K	Property class 70 EN ISO 3506:2009 1.4401; 1.4404; 1.4578; 1.4571; 1.4439; 1.4362 EN 10088-1:2014	Property class 70 EN ISO 3506-1:2009 1.4565; 1.4529 EN 10088-1:2014
6	Screw or threaded rod for fischer internal threaded anchor	Property class 5.8 or 8.8; EN ISO 898-1:2013 zinc plated $\geq 5\mu\text{m}$, ISO 4042:1999 A2K	Property class 70 EN ISO 3506:2009 1.4401; 1.4404; 1.4578; 1.4571; 1.4439; 1.4362 EN 10088-1:2014	Property class 70 EN ISO 3506-1:2009 1.4565; 1.4529 EN 10088-1:2014
7	Reinforcing bar EN 1992-1-1:2004 and AC:2010, Annex C	Bars and de-coiled rods class B or C with f_{yk} and k according to NDP or NCL of EN 1992-1-1/NA:2013 $f_{uk} = f_{tk} = k \cdot f_{yk}$ (k see Annex B 5)		
8	Rebar anchor FRA	Rebar part: Bars and de-coiled rods class B or C with f_{yk} and k according to NDP or NCL of EN 1992-1-1/NA:2013 $f_{uk} = f_{tk} = k \cdot f_{yk}$ (k see Annex B 5)	Threaded part: Property class 70 ISO 3506:2009 1.4565; 1.4529 EN 10088-1:2014	



fischer injection system FIS EM

Product description
Materials

Annex A 3

Specifications of intended use (part 1)

Table B1: Overview use categories and performance categories

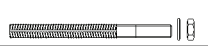
Anchorages subject to		FIS EM with ...							
		Threaded rod 	fischer internal threaded anchor RG MI 	Reinforcing bar 	fischer rebar anchor FRA 				
Hammer drilling		all sizes							
Diamond drilling		all sizes							
Static and quasi static load, in	un-cracked concrete	all sizes	Tables: C1, C2, C9, C10	all sizes	Tables: C3, C4, C11, C12,	all sizes	Tables: C5, C6, C13, C14	all sizes	Tables: C7, C8, C15, C16
	cracked concrete								
Seismic performance category (only hammer drilling)	C1	M10 – M30	Table C17	-----		Ø 10 - Ø32	Table C18	-----	
	C2	M12, M16, M20, M24	Table C19	-----		-----	-----	-----	
Use category	Dry or wet concrete	all sizes							
	Flooded hole	all sizes							
Installation temperature		+5°C to +40°C							
service temperature	Temperature range I	-40°C to +60°C		(max. long term temperature +35°C and max. short term temperature +60°C)					
	Temperature range II	-40°C to +72°C		(max. long term temperature +50°C and max. short term temperature +72°C)					

Base materials:

- Reinforced or unreinforced normal weight concrete according to EN 206:2013
- Strength classes C20/25 to C50/60 according to EN 206:2013

Use conditions (Environmental conditions):

- Structures subject to dry internal conditions (zinc coated steel, stainless steel or high corrosion resistant steel)
- Structures subject to external atmospheric exposure including industrial and marine environment, if no particular aggressive conditions exist (stainless steel or high corrosion resistant steel)
- Structures subject to permanently damp internal condition or in other particular aggressive conditions (high corrosion resistant steel)

Note: Particular aggressive conditions are e.g. permanent, alternating immersion in seawater or the splash zone of seawater, chloride atmosphere of indoor swimming pools or atmosphere with extreme chemical pollution (e.g. in desulphurization plants or road tunnels where de-icing materials are used)

fischer injection system FIS EM

Intended Use
Specifications (part 1)

Annex B 1

Specifications of intended use (part 2)

Design:

- Anchorages have to be designed under the responsibility of an engineer experienced in anchorages and concrete work
- Verifiable calculation notes and drawings are prepared taking account of the loads to be anchored. The position of the anchor is indicated on the design drawings (e. g. position of the anchor relative to reinforcement or to supports, etc.)
- Anchorages under static or quasi-static actions are designed in accordance with TR 029 or CEN/TS 1992-4:2009
- Anchorages under seismic actions have to be designed in accordance with TR 045

Installation:

- Anchor installation carried out by appropriately qualified personnel and under the supervision of the person responsible for technical matters of the site.
- In case of aborted hole: The hole shall be filled with mortar
- Marking and keeping the effective anchorage depth

Commercial standard threaded rods, washers and hexagon nuts may also be used if the following requirements are fulfilled:

- Materials, dimensions and mechanical properties according to Annex A 3, Table A1
- Inspection certificate 3.1 according to EN 10204:2004, the documents should be stored
- Marking of embedment depth

fischer injection system FIS EM

Intended Use
Specifications (part 2)

Annex B 2

Table B2: Installation parameters for threaded rods

Size	[-]	M8	M10	M12	M14	M16	M20	M22	M24	M27	M30	
Width across flat	SW	13	17	19	22	24	30	32	36	41	46	
Nominal drill bit diameter	d_0 [mm]	12	14	14	16	18	24	25	28	30	35	
Depth of drill hole	h_0 [mm]	$h_0 = h_{ef}$										
Effective anchorage depth	$h_{ef,min}$ [mm]	60	60	70	75	80	90	93	96	108	120	
	$h_{ef,max}$ [mm]	160	200	240	280	320	400	440	480	540	600	
Minimum spacing and minimum edge distance	$s_{min} = c_{min}$ [mm]	40	45	55	60	65	85	95	105	120	140	
Diameter of clearance hole in the fixture ¹⁾	pre-positioned anchorage d_f [mm]	9	12	14	16	18	22	24	26	30	33	
	Push through anchorage d_f [mm]	14	16	16	18	20	26	28	30	33	40	
Minimum thickness of concrete member	h_{min} [mm]	$h_{ef} + 30 \geq 100$			$h_{ef} + 2d_0$							
Maximum torque moment	$T_{inst,max}$ [Nm]	10	20	40	50	60	120	135	150	200	300	

¹⁾ For larger clearance holes in the fixture see TR 029, 4.2.2.1 or CEN/TS 1992-4-1:2009, 5.2.3.1

fischer threaded rod:

Alternative point geometry threaded rod FIS A

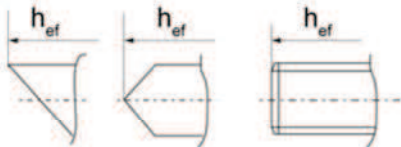

Alternative point geometry threaded rod RGM

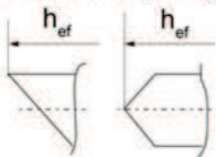

Alternative head geometry threaded rod FIS A and RGM

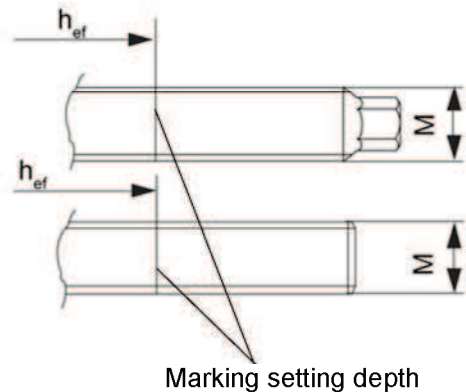

Marking (on random place):

- Property class 8.8 or high corrosion-resistant steel, property class 80: •
- Stainless steel A4, property class 50 and high corrosion-resistant steel, property class 50: ••

fischer injection system FIS EM

Intended Use
Installation parameters threaded rods

Annex B 3

Table B3: Installation parameters fischer internal threaded anchors RG MI

Size		M8	M10	M12	M16	M20
Diameter of anchor	d_H [mm]	12	16	18	22	28
Nominal drill bit diameter	d_0 [mm]	14	18	20	24	32
Drill hole depth	h_0 [mm]	$h_0 = h_{ef}$				
Effective anchorage depth ($h_{ef} = L_H$)	h_{ef} [mm]	90	90	125	160	200
Maximum torque moment	$T_{inst,max}$ [Nm]	10	20	40	80	120
Minimum spacing and minimum edge distance	$s_{min} = c_{min}$ [mm]	55	65	75	95	125
Diameter of clearance hole in the fixture ¹⁾	d_f [mm]	9	12	14	18	22
Minimum thickness of concrete member	h_{min} [mm]	120	125	165	205	260
Maximum screw-in depth	$l_{E,max}$ [mm]	18	23	26	35	45
Minimum screw-in depth	$l_{E,min}$ [mm]	8	10	12	16	20

¹⁾ For larger clearance holes in the fixture see TR 029, 4.2.2.1 or CEN/TS 1992-4-1:2009, 5.2.3.1

fischer internal threaded anchor RG MI

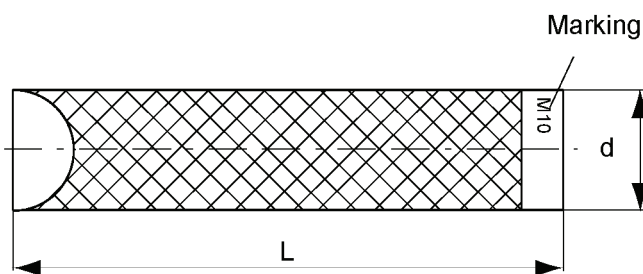
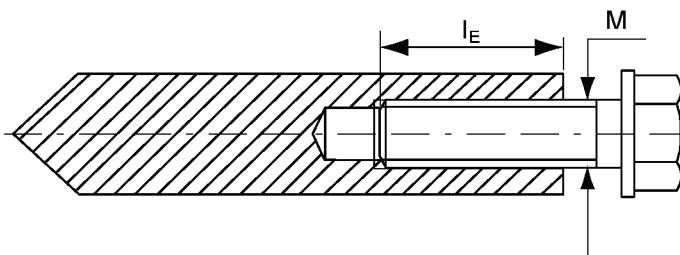

Marking: Anchor size
 e.g.: **M10**
 Stainless steel additional **A4**
 e.g.: **M10 A4**
 High corrosion-resistant steel additional **C**
 e.g.: **M10 C**

Fastening screw or threaded rods (including nut and washer) must comply with the appropriate material and strength class of Table A1

fischer injection system FIS EM

Intended Use
 Installation parameters fischer internal threaded anchors RG MI

Annex B 4

Table B4: Installation parameters reinforcing bars

Reinforcing bar		∅	8	10	12	14	16	18	20	22	24
Nominal drill bit diameter	d_0 [mm]		12	14	16	18	20	25	25	30	30
Drill hole depth	h_0 [mm]		$h_0 = h_{ef}$								
Effective anchorage depth	$h_{ef,min}$ [mm]		60	60	70	75	80	85	90	94	98
	$h_{ef,max}$ [mm]		160	200	240	280	320	360	400	440	480
Minimum spacing and minimum edge distance	$s_{min} = c_{min}$ [mm]		40	45	55	60	65	75	85	95	105
Minimum thickness of concrete member	h_{min} [mm]		$h_{ef} + 30$ ≥ 100		$h_{ef} + 2d_0$						

Reinforcing bar		∅	25	26	28	30	32	34	36	40	
Nominal drill bit diameter	d_0 [mm]		30	35	35	40	40	40	45	55	
Drill hole depth	h_0 [mm]		$h_0 = h_{ef}$								
Effective anchorage depth	$h_{ef,min}$ [mm]		100	104	112	120	128	136	144	160	
	$h_{ef,max}$ [mm]		500	520	560	600	640	680	720	800	
Minimum spacing and minimum edge distance	$s_{min} = c_{min}$ [mm]		110	120	130	140	160	170	180	200	
Minimum thickness of concrete member	h_{min} [mm]		$h_{ef} + 2d_0$								

Reinforcing bar

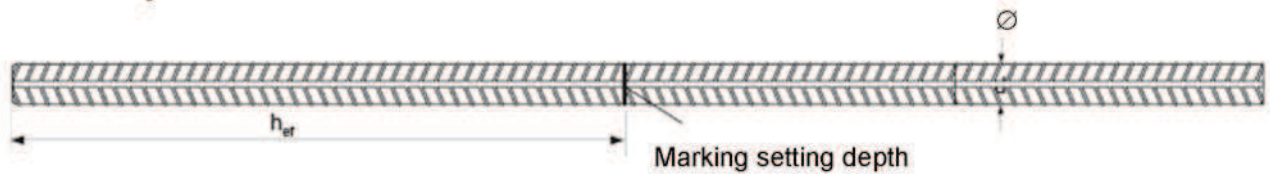

Properties of reinforcement: refer to EN 1992-1-1 Annex C, Table C.1 and C.2N

Product form		Non-zinc-plated bars and de-coiled rod	
Class		B C	
Characteristic yield strength f_{yk} or $f_{0,2k}$ [MPa]		400 to 600	
Minimum value of $k = (f_t / f_y)_k$		$\geq 1,08$	$\geq 1,15$ $< 1,35$
Characteristic strain at maximum force ϵ_{uk} [%]		$\geq 5,0$	$\geq 7,5$
Bentability		Bend / Rebind test	
Maximum deviation from nominal mass (individual bar) [%]	Nominal bar size [mm]	≤ 8	$\pm 6,0$
		> 8	$\pm 4,5$
Bond: Minimum relative rib area, $f_{R,min}$ (determination acc. to EN 15630)	Nominal bar size [mm]	8 to 12	0,040
		> 12	0,056

Rib height h:

The rib height h must be $0,05 \cdot \varnothing \leq h \leq 0,07 \cdot \varnothing$
 \varnothing = nominal bar size

fischer injection system FIS EM

Intended Use
 Installation parameters reinforcing bars

Annex B 5



Table B5: Installation parameters fischer rebar anchor FRA

Thread diameter		M12	M16	M20	M24
Nominal bar size	\varnothing [mm]	12	16	20	25
Width across flat	SW [mm]	19	24	30	36
Nominal drill bit diameter	d_0 [mm]	16	20	25	30
Depth of drill hole ($h_0 = l_{ges}$)	h_0 [mm]	$h_{ef} + l_e$			
Effective anchorage depth	$h_{ef,min}$ [mm]	70	80	90	96
	$h_{ef,max}$ [mm]	140	220	300	380
Distance concrete surface to welded joint	l_e [mm]	100			
Minimum spacing and minimum edge distance	$s_{min}=c_{min}$ [mm]	55	65	85	105
Diameter of clearance hole in the fixture ¹⁾	pre-positioned anchorage $\leq d_f$ [mm]	14	18	22	26
	push through anchorage $\leq d_f$ [mm]	18	22	26	32
Minimum thickness of concrete member	h_{min} [mm]	$h_0 + 30$ ≥ 100	$h_0 + 2d_0$		
Maximum torque moment	$T_{inst,max}$ [Nm]	40	60	120	150

¹⁾ For larger clearance holes in the fixture see TR 029, 4.2.2.1 or CEN/TS 1992-4-1:2009, 5.2.3.1

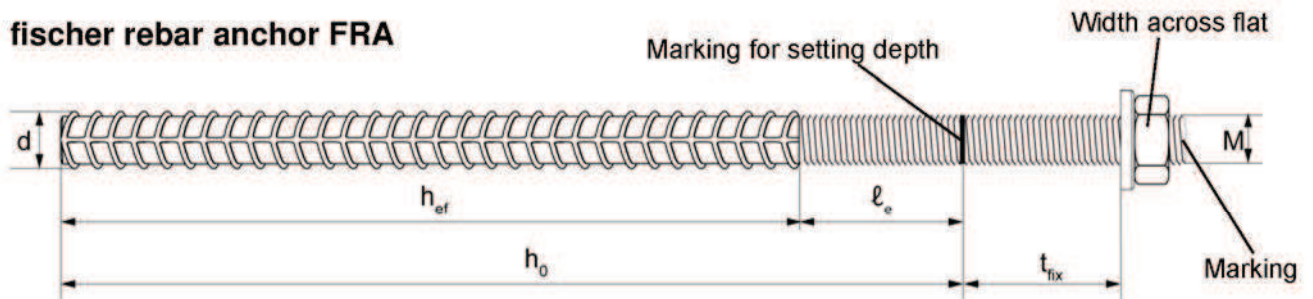
fischer rebar anchor FRA



Marking: on head e.g.:  FRA (for stainless steel);
 FRA C (for high corrosion-resistant steel)

fischer injection system FIS EM

Intended Use
Installation parameters rebar anchor FRA

Annex B 6

Table B6: Parameters of steel brush FIS BS Ø

Drill bit diameter	[mm]	12	14	16	18	20	24	25	28	30	32	35	40	45	55
Steel brush diameter d_b	[mm]	14	16	20		25	26	27	30	40			42	47	58

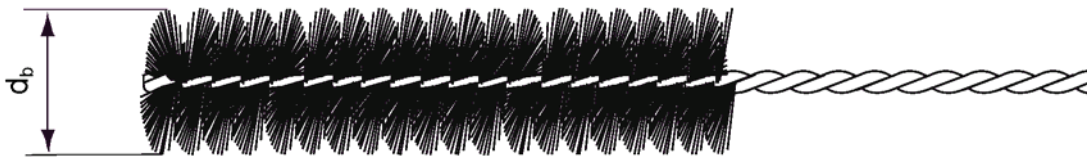

Table B7: Maximum processing time of the mortar and minimum curing time

System temperature [°C]	Maximum processing time [minutes]	Minimum curing time ¹⁾ [hours]
+5 to +10	120	40
≥ +10 to +20	30	18
≥ +20 to +30	14	10
≥ +30 to +40	7	5







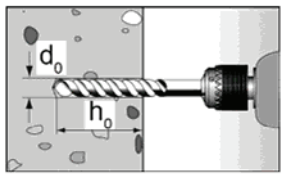

¹⁾ In wet concrete or flooded holes the curing times must be doublet.

fischer injection system FIS EM

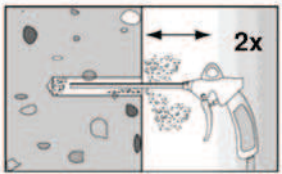

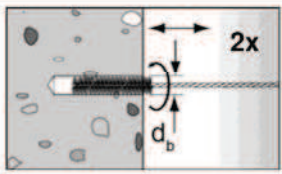
Intended Use
 Cleaning tools
 Processing times and curing times

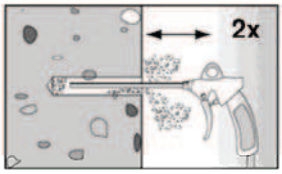
Annex B 7

Installation instructions part 1
Drilling and cleaning the hole (hammer-drilling)

1		<p>Drill the hole. Drill hole diameter d_0 and drill hole depth h_0 see Tables B2, B3, B4, B5.</p>	
2		<p>Clean the drill hole: Blow out the drill hole two times, using oil-free compressed air ($p \geq 6$ bar)</p>	
3		<p>Brush the drill hole two times. For drill hole diameter ≥ 30 mm use a power drill. For deep holes use an extension. Corresponding brushes see Table B6</p>	
4		<p>Clean the drill hole: Blow out the drill hole two times, using oil-free compressed air ($p \geq 6$ bar)</p>	

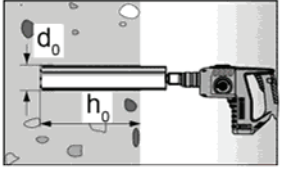
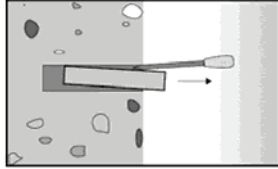
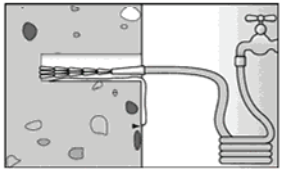
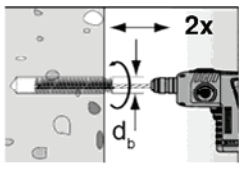
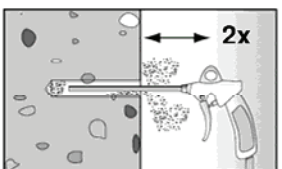
Drilling and cleaning the hole (diamond-drilling)

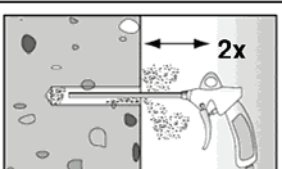
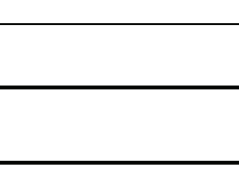
1		<p>Drill the hole. Drill hole diameter d_0 and drill hole depth h_0 see Tables B2, B3, B4, B5.</p>		<p>Break the drill core and draw it out.</p>
2		<p>Flush the drill hole until the water comes clear.</p>		<p>Brush the drill hole two times using a power drill. Corresponding brushes see Table B6</p>
3		<p>Blow out the drill hole two times, using oil-free compressed air ($p > 6$ bar)</p>		<p>Blow out the drill hole two times, using oil-free compressed air ($p > 6$ bar)</p>
4		<p>Blow out the drill hole two times, using oil-free compressed air ($p > 6$ bar)</p>		<p>Blow out the drill hole two times, using oil-free compressed air ($p > 6$ bar)</p>





fischer injection system FIS EM

Intended use
 Installation instructions part 1

Annex B 8

Installation instructions part 2

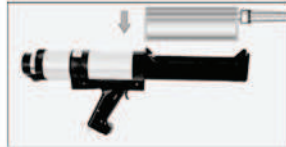

Preparing the cartridge

5		<p>Twist off the sealing cap</p> <p>Twist on the static mixer (the spiral in the static mixer must be clearly visible).</p>
6		 <p>Place the cartridge into the dispenser.</p>
7		 <p>Press approx. 10 cm of material out until the resin is evenly grey in colour. Don't use mortar that is not uniformly grey.</p>

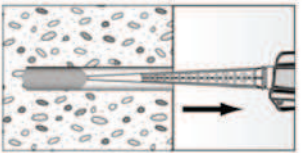
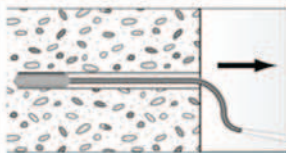
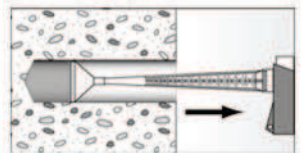
Injection of the mortar

8	 <p>Fill approx. 2/3 of the drill hole with mortar. Always begin from the bottom of the hole and avoid bubbles.</p>	 <p>For drill hole depth ≥ 150 mm use an extension tube.</p>	 <p>For overhead installation, deep holes $h_0 > 250$ mm or drill hole diameter $d_0 \geq 40$ mm use an injection-adapter.</p>
---	---	--	---

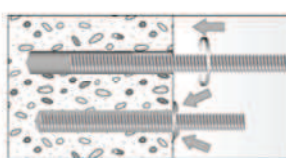
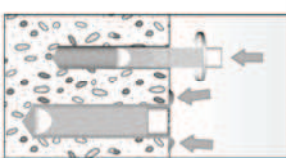
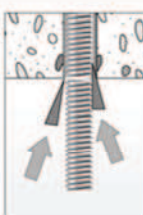
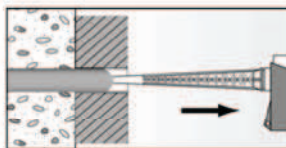
Installation threaded rods or fischer internal threaded anchors RG MI

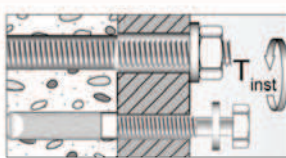
9			<p>Only use clean and oil-free anchor elements. Mark the setting depth of the anchor. Press the threaded rod or internal threaded anchor down to the bottom of the hole, turning it slightly while doing so. After inserting the anchor element, excess mortar must emerge around the anchor element.</p>
	 <p>For overhead installations support the threaded rod with wedges.</p>	 <p>For push through installation fill the annular clearance with mortar.</p>	
10	 <p>Wait for the specified curing time, t_{cure} see Table B7.</p>	 <p>Mounting the fixture $T_{inst,max}$ see Tables B2, B3.</p>	



fischer injection system FIS EM

Intended use
Installation instructions part 2

Annex B 9

Installation instructions part 3

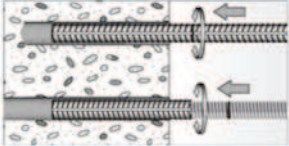
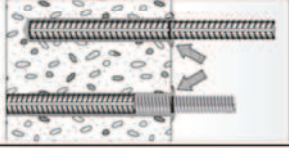
Installation reinforcing bars and fischer FRA

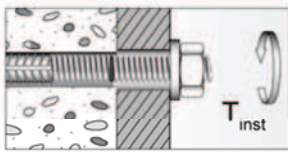
<p>9</p>		<p>Only use clean and oil-free reinforcing bars. Mark the setting depth of the reinforcing bar. Using a turning movement, push the reinforcement bar or the FRA vigorously into the filled hole up to the insertion depth marking.</p>
		<p>When reaching the setting depth mark, excess mortar must emerge from the mouth of the drill hole.</p>
<p>10</p>	 <p>Wait for the specified curing time t_{cure} see Table B7.</p>	 <p>Mounting the fixture $T_{inst,max}$ see Table B5.</p>

fischer injection system FIS EM

Intended use
 Installation instructions part 3

Annex B 10

Table C1: Characteristic values of resistance for threaded rods under tension

Size				M8	M10	M12	M14	M16	M20	M22	M24	M27	M30	
Installation safety factor	dry and wet concrete	$\gamma_2 =$	[-]	1,0						1,2				
	flooded hole	γ_{inst}	[-]	1,4										
Steel failure														
Characteristic resistance			$N_{Rk,s}$	[kN]			$A_s \times f_{uk}$							
Combined pullout and concrete cone failure														
Diameter of calculation			d	[mm]	8	10	12	14	16	20	22	24	27	30
Characteristic bond resistance in un-cracked concrete C20/25														
hammer-drilling (dry and wet concrete)														
Temperature range I ¹⁾			$\tau_{Rk,ucr}$	[N/mm ²]	16	16	15	14	14	13	13	13	12	12
Temperature range II ¹⁾			$\tau_{Rk,ucr}$	[N/mm ²]	15	14	14	13	13	12	12	12	11	11
hammer-drilling (flooded hole)														
Temperature range I ¹⁾			$\tau_{Rk,ucr}$	[N/mm ²]	16	16	15	13	13	11	11	10	10	9
Temperature range II ¹⁾			$\tau_{Rk,ucr}$	[N/mm ²]	15	14	14	13	12	11	10	10	9	9
diamond-drilling (dry and wet concrete)														
Temperature range I ¹⁾			$\tau_{Rk,ucr}$	[N/mm ²]	16	15	13	12	12	10	10	10	9	9
Temperature range II ¹⁾			$\tau_{Rk,ucr}$	[N/mm ²]	15	14	12	11	11	10	9	9	8	8
diamond-drilling (flooded hole)														
Temperature range I ¹⁾			$\tau_{Rk,ucr}$	[N/mm ²]	16	15	13	12	12	10	10	10	9	9
Temperature range II ¹⁾			$\tau_{Rk,ucr}$	[N/mm ²]	15	14	12	11	11	10	9	9	8	8
Factor for un-cracked			k_{ucr}	[-]	10,1									
¹⁾ See Annex B 1														
fischer injection system FIS EM											Annex C 1			
Performances Design of bonded anchors Static or quasi-static action in tension														

Table C1.1: Characteristic values of resistance for threaded rods under tension

Size				M8	M10	M12	M14	M16	M20	M22	M24	M27	M30
Installation safety factor	dry and wet concrete	$\gamma_2 =$	[-]	1,0						1,2			
	flooded hole	γ_{inst}	[-]	1,2						1,4			
Characteristic bond resistance in cracked concrete C20/25													
hammer and diamond drilling (dry and wet concrete)													
Temperature range I ¹⁾			$\tau_{Rk,cr}$ [N/mm ²]	7	7	7	7	6	6	7	7	7	7
Temperature range II ¹⁾			$\tau_{Rk,cr}$ [N/mm ²]	7	7	7	7	6	6	7	7	7	7
hammer and diamond drilling (flooded hole)													
Temperature range I ¹⁾			$\tau_{Rk,cr}$ [N/mm ²]	6	7,5	7,5	7	6	6	6	6	6	6
Temperature range II ¹⁾			$\tau_{Rk,cr}$ [N/mm ²]	6	7	7	7	6	6	6	6	6	6
Factor for un-cracked			k_{cr} [-]	7,2									
Increasing factor for τ_{Rk}	Ψ_c	C25/30	[-]	1,02									
		C30/37	[-]	1,04									
		C35/45	[-]	1,06									
		C40/50	[-]	1,07									
		C45/55	[-]	1,08									
		C50/60	[-]	1,09									
Splitting failure													
Edge distance	$C_{cr,sp}$	$h / h_{ef} \geq 2,0$	[mm]	$1,0 h_{ef}$									
		$2,0 h / h_{ef}$	[mm]	$4,6 h_{ef} - 1,8 h$									
		$h / h_{ef} \leq 1,3$	[mm]	$2,26 h_{ef}$									
Axial distance	$S_{cr,sp}$	[mm]	$2 C_{cr,sp}$										

¹⁾ See Annex B 1

Table C2: Characteristic values of resistance for threaded rods under shear

Size				M8	M10	M12	M14	M16	M20	M22	M24	M27	M30
Installation safety factor		$\gamma_2 = \gamma_{inst}$	[-]	1,0									
Steel failure without lever arm													
Characteristic resistance		$V_{Rk,s}$ [kN]		$0,5 A_s \times f_{uk}$									
Ductility factor acc. to CEN/TS 1992-4-5:2009 Section 6.3.2.1		k_2	[-]	0,8									
Steel failure with lever arm													
Characteristic resistance		$M^0_{Rk,s}$ [Nm]		$1,2 \times W_{el} \times f_{uk}$									
Concrete pryout failure													
Factor k acc. to TR029 Section 5.2.3.3 resp. k_3 acc. to CEN/TS 1992-4-5:2009 Section 6.3.3		$k_{(3)}$	[-]	2,0									
Concrete edge failure													
Effective length of anchor		l_f	[mm]	$l_f = \min (h_{ef}, 8 d)$									
Diameter of calculation		d	[mm]	8	10	12	14	16	20	22	24	27	30

fischer injection system FIS EM

Performances
 Design of bonded anchors
 Static or quasi-static action in tension and under shear loads

Annex C 2

Table C3: Characteristic values of resistance for fischer internal threaded anchors
RG MI under tension load

Size				M8	M10	M12	M16	M20
Installation safety factor	dry and wet concrete	γ_2	[-]	1,0			1,2	
	flooded hole	γ_{inst}	[-]	1,2			1,4	
Steel failure								
Characteristic resistance with screw	$N_{Rk,s}$	Property class	5.8 [kN]	19	29	43	79	123
			8.8 [kN]	29	47	68	108	179
		Property class	A4 [kN]	26	41	59	110	172
		class 70	C [kN]	26	41	59	110	172
Combined pullout and concrete cone failure								
Diameter of calculation			d [mm]	12	16	18	22	28
Characteristic bond resistance in un-cracked concrete C20/25								
hammer-drilling (dry and wet concrete)								
Temperature range I ¹⁾			$\tau_{Rk,ucr}$ [N/mm ²]	15	14	14	13	12
Temperature range II ¹⁾			$\tau_{Rk,ucr}$ [N/mm ²]	14	13	13	12	11
hammer-drilling (flooded hole)								
Temperature range I ¹⁾			$\tau_{Rk,ucr}$ [N/mm ²]	14	12	12	11	10
Temperature range II ¹⁾			$\tau_{Rk,ucr}$ [N/mm ²]	13	12	11	10	9
diamond-drilling (dry and wet concrete)								
Temperature range I ¹⁾			$\tau_{Rk,ucr}$ [N/mm ²]	13	12	11	10	9
Temperature range II ¹⁾			$\tau_{Rk,ucr}$ [N/mm ²]	12	11	10	9	8
diamond-drilling (flooded hole)								
Temperature range I ¹⁾			$\tau_{Rk,ucr}$ [N/mm ²]	13	12	11	10	9
Temperature range II ¹⁾			$\tau_{Rk,ucr}$ [N/mm ²]	12	11	10	9	8
Factor for un-cracked concrete			k_{ucr} [-]	10,1				

¹⁾ See Annex B 1

fischer injection system FIS EM

Performances

Design of bonded anchors
Static or quasi-static action in tension

Annex C 3

Table C3.1: Characteristic values of resistance for fischer internal threaded anchors
RG MI under tension load

Size			M8	M10	M12	M16	M20
Characteristic bond resistance in cracked concrete C20/25							
hammer and diamond drilling (dry and wet concrete)							
Temperature range I ¹⁾	$\tau_{Rk,cr}$	[N/mm ²]	7	6	6	7	7
Temperature range II ¹⁾	$\tau_{Rk,cr}$	[N/mm ²]	7	6	6	7	7
hammer and diamond drilling (dry and wet concrete)							
Temperature range I ¹⁾	$\tau_{Rk,cr}$	[N/mm ²]	7	6,5	6	6	6
Temperature range II ¹⁾	$\tau_{Rk,cr}$	[N/mm ²]	7	6	6	6	6
Factor for cracked concrete	k_{cr}	[-]	7,2				
Increasing factor for τ_{Rk}	Ψ_c	C25/30	[-]	1,02			
		C30/37	[-]	1,04			
		C35/45	[-]	1,06			
		C40/50	[-]	1,07			
		C45/55	[-]	1,08			
		C50/60	[-]	1,09			
Splitting failure							
Edge distance	$c_{cr,sp}$	$h/h_{ef} \geq 2,0$	[mm]	1,0 h_{ef}			
		$2,0 > h/h_{ef} > 1,3$	[mm]	4,6 $h_{ef} - 1,8 h$			
		$h/h_{ef} \leq 1,3$	[mm]	2,26 h_{ef}			
Axial distance	$s_{cr,sp}$		[mm]	2 $c_{cr,sp}$			

¹⁾ See Annex B 1

fischer injection system FIS EM

Performances

Design of bonded anchors
Static or quasi-static action in tension

Annex C 4

Table C4: Characteristic values of resistance for fischer internal threaded anchors
RG MI under shear load

Size				M8	M10	M12	M16	M20	
Installation safety factor		$\gamma_2 = \gamma_{inst}$	[-]	1,0					
Steel failure without lever arm									
Characteristic resistance	$V_{Rk,s}$	Property class	5.8	[kN]	9,2	14,5	21,1	39,2	62,0
			8.8	[kN]	14,6	23,2	33,7	54,0	90,0
		Property class 70	A4	[kN]	12,8	20,3	29,5	54,8	86,0
			C	[kN]	12,8	20,3	29,5	54,8	86,0
Ductility factor acc. to CEN/TS 1992-4-5: 2009 Section 6.3.2.1		k_2	[-]	0,8					
Steel failure with lever arm									
Characteristic resistance	$M^0_{Rk,s}$	Property class	5.8	[Nm]	20	39	68	173	337
			8.8	[Nm]	30	60	105	266	519
		Property class 70	A4	[Nm]	26	52	92	232	454
			C	[Nm]	26	52	92	232	454
Concrete pryout failure									
Factor k acc. to TR029 Section 5.2.3.3 resp. k_3 acc. to CEN/TS 1992-4-5:2009 Section 6.3.3		$k_{(3)}$	[-]	2,0					
Concrete edge failure									
Effective length of anchor		l_f	[mm]	$l_f = \min (h_{ef}, 8 d)$					
Diameter of calculation		d	[mm]	8	10	12	16	20	

fischer injection system FIS EM

Performances
Design of bonded anchors
Static or quasi-static action under shear loads

Annex C 5

Table C5: Characteristic values of resistance for reinforcing bars under tension loads Hammer-drilling											
Reinforcing bar	Ø	8	10	12	14	16	18	20	22	24	
Installation safety factor	dry and wet concrete	$\gamma_2 =$	[-]						1,0		1,2
	flooded hole	γ_{inst}	[-]						1,4		
Combined pullout and concrete cone failure											
Diameter of calculation	d	[mm]	8	10	12	14	16	18	20	22	24
Characteristic bond resistance in un-cracked concrete											
hammer-drilling (dry and wet concrete)											
Temperature range I ¹⁾	$\tau_{Rk,ucr}$	[N/mm ²]	16	16	15	14	14	14	13	13	13
Temperature range II ¹⁾	$\tau_{Rk,ucr}$	[N/mm ²]	15	14	14	13	13	13	12	12	12
hammer-drilling (flooded hole)											
Temperature range I ¹⁾	$\tau_{Rk,ucr}$	[N/mm ²]	16	16	14	13	12	12	11	11	10
Temperature range II ¹⁾	$\tau_{Rk,ucr}$	[N/mm ²]	15	14	13	12	11	12	11	10	10
Reinforcing bar	Ø	25	26	28	30	32	34	36	40		
Installation safety factor	dry and wet concrete	$\gamma_2 =$	[-]						1,2		
	flooded hole	γ_{inst}	[-]						1,4		
Combined pullout and concrete cone failure											
Diameter of calculation	d	[mm]	25	26	28	30	32	34	36	40	
Characteristic bond resistance in un-cracked concrete											
hammer-drilling (dry and wet concrete)											
Temperature range I ¹⁾	$\tau_{Rk,ucr}$	[N/mm ²]	13	13	13	12	12	12	12	12	
Temperature range II ¹⁾	$\tau_{Rk,ucr}$	[N/mm ²]	12	11	11	11	11	11	11	10	
hammer-drilling (flooded hole)											
Temperature range I ¹⁾	$\tau_{Rk,ucr}$	[N/mm ²]	10	10	10	9	9	9	8	8	
Temperature range II ¹⁾	$\tau_{Rk,ucr}$	[N/mm ²]	9	9	9	9	8	8	8	8	
¹⁾ See Annex B 1											
fischer injection system FIS EM									Annex C 6		
Performances Design of bonded anchors Static or quasi-static action in tension											

Table C5.1: Characteristic values of resistance for reinforcing bars under tension loads												
Reinforcing bar		\emptyset	8	10	12	14	16	18	20	22	24	
Installation safety factor	dry and wet concrete	$\gamma_2 =$	[-]		1,0						1,2	
	flooded hole	γ_{inst}	[-]		1,4							
Characteristic bond resistance in un-cracked concrete C20/25												
diamond-drilling (dry and wet concrete)												
Temperature range I ¹⁾	$\tau_{Rk,ucr}$	[N/mm ²]	16	15	13	12	12	10	10	10	10	
Temperature range II ¹⁾	$\tau_{Rk,ucr}$	[N/mm ²]	15	14	12	11	11	10	10	9	9	
diamond-drilling (flooded hole)												
Temperature range I ¹⁾	$\tau_{Rk,ucr}$	[N/mm ²]	16	15	13	12	12	11	10	10	10	
Temperature range II ¹⁾	$\tau_{Rk,ucr}$	[N/mm ²]	15	14	12	11	11	10	10	9	9	
Characteristic bond resistance in un-cracked concrete C20/25												
diamond-drilling (dry and wet concrete)												
Reinforcing bar		\emptyset	25	26	28	30	32	34	36	40		
Installation safety factor	dry and wet concrete	$\gamma_2 =$	[-]		1,2							
	flooded hole	γ_{inst}	[-]		1,4							
Characteristic bond resistance in un-cracked concrete C20/25												
diamond-drilling (dry and wet concrete)												
Temperature range I ¹⁾	$\tau_{Rk,ucr}$	[N/mm ²]	9	9	9	9	8	8	8	7		
Temperature range II ¹⁾	$\tau_{Rk,ucr}$	[N/mm ²]	9	8	8	8	8	7	7	7		
diamond-drilling (flooded hole)												
Temperature range I ¹⁾	$\tau_{Rk,ucr}$	[N/mm ²]	9	9	9	9	8	8	8	7		
Temperature range II ¹⁾	$\tau_{Rk,ucr}$	[N/mm ²]	9	8	8	8	8	7	7	7		
Factor for un-cracked concrete	k_{ucr}	[-]	10,1									
¹⁾ See Annex B 1												
fischer injection system FIS EM									Annex C 7			
Performances Design of bonded anchors Static or quasi-static action in tension												

Table C5.2: Characteristic values of resistance for reinforcing bars under tension loads

Reinforcing bar				Ø	8	10	12	14	16	18	20	22	24	
Installation safety factor	dry and wet concrete	$\gamma_2 =$	[-]	-	1,0						1,2			
	flooded hole	γ_{inst}	[-]	-	1,2				1,4					
Characteristic bond resistance in cracked concrete C20/25														
hammer and diamond drilling (dry and wet concrete)														
Temperature range I ¹⁾	$\tau_{Rk,cr}$	[N/mm ²]		7	7	7	7	6	6	6	6	7	7	
Temperature range II ¹⁾	$\tau_{Rk,ucr}$	[N/mm ²]		7	7	7	7	6	6	6	6	7	7	
hammer and diamond drilling (flooded hole)														
Temperature range I ¹⁾	$\tau_{Rk,cr}$	[N/mm ²]		6	7,5	6,5	6,5	6,5	6	6	6	6	6	
Temperature range II ¹⁾	$\tau_{Rk,cr}$	[N/mm ²]		6	6,5	6,5	6	6	6	6	6	6	6	
Reinforcing bar				Ø	25	26	28	30	32	34	36	40		
Installation safety factor	dry and wet concrete	$\gamma_2 =$	[-]	1,2										
	flooded hole	γ_{inst}	[-]	1,4										
Characteristic bond resistance in cracked concrete C20/25														
hammer and diamond drilling (dry and wet concrete)														
Temperature range I ¹⁾	$\tau_{Rk,cr}$	[N/mm ²]		7	7	7	7	5	5	5	5			
Temperature range II ¹⁾	$\tau_{Rk,cr}$	[N/mm ²]		7	7	7	7	5	5	5	5			
hammer and diamond drilling (flooded hole)														
Temperature range I ¹⁾	$\tau_{Rk,cr}$	[N/mm ²]		6	6	6	6	5	5	5	5			
Temperature range II ¹⁾	$\tau_{Rk,cr}$	[N/mm ²]		6	6	6	6	5	5	5	5			
Factor for cracked concrete				k_{cr}	[-]						7,2			
Increasing factor for τ_{RK}				Ψ_c	C25/30	[-]						1,02		
					C30/37	[-]						1,04		
					C35/45	[-]						1,06		
					C40/50	[-]						1,07		
					C45/55	[-]						1,08		
					C50/60	[-]						1,09		
Splitting failure														
Edge distance $c_{cr,sp}$		$h/h_{ef} \geq 2,0$	[mm]							1,0 h_{ef}				
		$2,0 > h/h_{ef} > 1,3$	[mm]							4,6 $h_{ef} - 1,8 h$				
		$h/h_{ef} \leq 1,3$	[mm]							2,26 h_{ef}				
Axial distance		$s_{cr,sp}$	[mm]							2 $c_{cr,sp}$				
1) See Annex B 1														
fischer injection system FIS EM											Annex C 8			
Performances Design of bonded anchors Static or quasi-static in tension														

Table C6: Characteristic values of resistance for reinforcing bars under shear loads										
Reinforcing bar	\emptyset	8	10	12	14	16	18	20	22	24
Diameter of calculation	d [mm]	8	10	12	14	16	18	20	22	24
Reinforcing bar	\emptyset	25	26	28	30	32	34	36	40	
Diameter of calculation	d [mm]	25	26	28	30	32	34	36	40	
Installation safety factor	$\gamma_2 = \gamma_{inst}$ [-]	1,0								
Steel failure without lever arm										
Characteristic resistance	$V_{Rk,s}$ [kN]	0,5 $A_s \times f_{uk}$								
Ductility factor acc. to CEN/TS 1992-4-5:2009 Section 6.3.2.1	k_2 [-]	0,8								
Steel failure with lever arm										
Characteristic resistance	$M^0_{Rk,s}$ [Nm]	1,2 $\times W_{el} \times f_{uk}$								
Concrete pryout failure										
Factor k acc. to TR029 Section 5.2.3.3 resp. k_3 acc. to CEN/TS 1992-4-5:2009 Section 6.3.3	$k_{(3)}$ [-]	2,0								
Concrete edge failure										
Effective length of anchor	l_f [mm]	$l_f = \min (h_{ef}; 8 d)$								
fischer injection system FIS EM										Annex C 9
Performances Design of bonded anchors Static or quasi-static action under shear loads										

Table C7: Characteristic values of resistance for fischer rebar anchors FRA under tension loads

Size				M12	M16	M20	M24
Installation safety factor	dry and wet concrete	$\gamma_2 =$	[-]	1,0			1,2
	flooded hole	γ_{inst}	[-]	1,2			1,4
Steel failure							
Characteristic resistance		$N_{Rk,s}$	[kN]	63	111	173	270
Partial safety factor		$\gamma_{Ms,N}^{2)}$	[-]	1,4			
Combined pullout and concrete cone failure							
Diameter of calculation		d	[mm]	12	16	20	25
Characteristic bond resistance in un-cracked concrete C20/25							
hammer-drilling (dry and wet concrete)							
Temperature range I ¹⁾		$\tau_{Rk,ucr}$	[N/mm ²]	15	14	13	13
Temperature range II ¹⁾		$\tau_{Rk,ucr}$	[N/mm ²]	14	13	12	12
hammer-drilling (flooded hole)							
Temperature range I ¹⁾		$\tau_{Rk,ucr}$	[N/mm ²]	15	13	11	10
Temperature range II ¹⁾		$\tau_{Rk,ucr}$	[N/mm ²]	14	12	11	10
diamond-drilling (dry and wet concrete)							
Temperature range I ¹⁾		$\tau_{Rk,ucr}$	[N/mm ²]	13	12	10	10
Temperature range II ¹⁾		$\tau_{Rk,ucr}$	[N/mm ²]	12	11	10	9
diamond-drilling (flooded hole)							
Temperature range I ¹⁾		$\tau_{Rk,ucr}$	[N/mm ²]	13	12	10	10
Temperature range II ¹⁾		$\tau_{Rk,ucr}$	[N/mm ²]	12	11	10	9
Factor for un-cracked concrete		k_{ucr}	[-]	10,1			

¹⁾ See Annex B 1

²⁾ In absence of other national regulations

fischer injection system FIS EM

Performances

Design of bonded anchors
Static or quasi-static action in tension

Annex C 10

Table C7.1: Characteristic values of resistance for fischer rebar anchors FRA under tension loads

Size			M12	M16	M20	M24	
Installation safety factor	dry and wet concrete	$\gamma_2 =$	[-]	1,0			1,2
	flooded hole	γ_{inst}	[-]	1,2			1,4
Characteristic bond resistance in cracked concrete C20/25							
hammer-drilling (dry and wet concrete)							
Temperature range I ¹⁾		$\tau_{Rk,cr}$	[N/mm ²]	7	6	6	7
Temperature range II ¹⁾		$\tau_{Rk,cr}$	[N/mm ²]	7	6	6	7
hammer-drilling (flooded hole)							
Temperature range I ¹⁾		$\tau_{Rk,cr}$	[N/mm ²]	7	6	6	6
Temperature range II ¹⁾		$\tau_{Rk,cr}$	[N/mm ²]	7	6	6	6
Factor for cracked concrete			k_{cr}	[-]	7,2		
Increasing factor for τ_{RK}	ψ_c	C25/30	[-]	1,02			
		C30/37	[-]	1,04			
		C35/45	[-]	1,06			
		C40/50	[-]	1,07			
		C45/55	[-]	1,08			
		C50/60	[-]	1,09			
Splitting failure							
Edge distance	$c_{cr,sp}$	$h/h_{ef} \geq 2,0$	[mm]	1,0 h_{ef}			
		$2,0 > h/h_{ef} > 1,3$	[mm]	4,6 $h_{ef} - 1,8 h$			
		$h/h_{ef} \leq 1,3$	[mm]	2,26 h_{ef}			
Axial distance	$s_{cr,sp}$	[mm]	2 $c_{cr,sp}$				

¹⁾ See Annex B 1

fischer injection system FIS EM

Performances

Design of bonded anchors
Static or quasi-static action in tension

Annex C 11

Table C8: Characteristic values of resistance for fischer rebar anchors FRA under shear load

Size			M12	M16	M20	M24
Installation safety factor	$\gamma_2 = \gamma_{inst}$	[-]	1,0			
Steel failure without lever arm						
Characteristic resistance	$V_{Rk,s}$	[kN]	30	55	86	124
Partial safety factor	$\gamma_{Ms,V}^{1)}$	[-]	1,56			
Ductility factor acc. to CEN/TS 1992-4-5:2009 Section 6.3.2.1	k_2	[-]	0,8			
Steel failure with lever arm						
Characteristic resistance	$M_{Rk,s}^0$	[Nm]	92	233	454	785
Partial safety factor	$\gamma_{Ms,V}^{1)}$	[-]	1,56			
Concrete pryout failure						
Factor k acc. to TR029 Section 5.2.3.3 resp. k_3 acc. to CEN/TS 1992-4-5:2009 Section 6.3.3	$k_{(3)}$	[-]	2,0			
Concrete edge failure						
Effective length of anchor	l_f	[mm]	$l_f = \min(h_{ef}; 8 d)$			
Diameter of calculation	d	[mm]	12	16	20	24

¹⁾ In absence of other national regulations

fischer injection system FIS EM

Performances

Design of bonded anchors
Static or quasi-static action under shear loads

Annex C 12

Table C9: Displacements under tension load for threaded rods¹⁾

Size			M8	M10	M12	M16	M20	M24	M27	M30
Un-cracked and cracked concrete; temperature range I, II										
Displacement	δ_{N0}	[mm/(N/mm ²)]	0,07	0,08	0,09	0,10	0,11	0,12	0,13	0,13
Displacement	$\delta_{N\infty}$	[mm/(N/mm ²)]	0,13	0,14	0,15	0,17	0,17	0,18	0,19	0,19

¹⁾ Calculation of the displacement for design load
 Displacement for short term load = $\delta_{N0} \cdot \tau_{sd} / 1,4$
 Displacement for long term load = $\delta_{N\infty} \cdot \tau_{sd} / 1,4$
 (τ_{sd} : design bond strength)

Table C10: Displacements under shear load for threaded rods¹⁾

Size			M8	M10	M12	M16	M20	M24	M27	M30
Un-cracked and cracked concrete; temperature range I, II										
Displacement	δ_{V0}	[mm/kN]	0,18	0,15	0,12	0,09	0,07	0,06	0,05	0,05
Displacement	$\delta_{V\infty}$	[mm/kN]	0,27	0,22	0,18	0,14	0,11	0,09	0,08	0,07

¹⁾ Calculation of the displacement for design load
 Displacement for short term load = $\delta_{V0} \cdot V_d / 1,4$
 Displacement for long term load = $\delta_{V\infty} \cdot V_d / 1,4$
 (V_d : design shear resistance)

Table C11: Displacements under tension load for fischer internal threaded anchors RG MI¹⁾

Size			M8	M10	M12	M16	M20
Un-cracked and cracked concrete; temperature range I, II							
Displacement	δ_{N0}	[mm/(N/mm ²)]	0,09	0,10	0,10	0,11	0,19
Displacement	$\delta_{N\infty}$	[mm/(N/mm ²)]	0,13	0,15	0,15	0,17	0,19

¹⁾ Calculation of the displacement for design load
 Displacement for short term load = $\delta_{N0} \cdot \tau_{sd} / 1,4$
 Displacement for long term load = $\delta_{N\infty} \cdot \tau_{sd} / 1,4$
 (τ_{sd} : design bond strength)

Table C12: Displacements under shear load for fischer internal threaded anchors RG MI¹⁾

Size			M8	M10	M12	M16	M20
Un-cracked and cracked concrete; temperature range I, II							
Displacement	δ_{V0}	[mm/kN]	0,12	0,09	0,08	0,07	0,05
Displacement	$\delta_{V\infty}$	[mm/kN]	0,18	0,14	0,12	0,10	0,08

¹⁾ Calculation of the displacement for design load
 Displacement for short term load = $\delta_{V0} \cdot V_d / 1,4$
 Displacement for long term load = $\delta_{V\infty} \cdot V_d / 1,4$
 (V_d : design shear resistance)

fischer injection system FIS EM

Performances
 Displacements threaded rods and fischer internal threaded anchor RG MI

Annex C 13

Table C13: Displacements under tension load for reinforcing bars ¹⁾

Size	Ø d	8	10	12	14	16	20	25	28	32	
Un-cracked and cracked concrete; temperature range I, II											
Displacement	δ_{N0}	[mm/(N/mm ²)]	0,07	0,08	0,09	0,09	0,10	0,11	0,12	0,13	0,13
Displacement	$\delta_{N\infty}$	[mm/(N/mm ²)]	0,12	0,13	0,13	0,15	0,16	0,16	0,18	0,20	0,20

¹⁾ Calculation of the displacement for design load
 Displacement for short term load = $\delta_{N0} \cdot \tau_{sd} / 1,4$
 Displacement for long term load = $\delta_{N\infty} \cdot \tau_{sd} / 1,4$
 (τ_{sd} : design bond strength)

Table C14: Displacements under shear load for reinforcing bars ¹⁾

Size	Ø d	8	10	12	14	16	20	25	28	32	
Un-cracked and cracked concrete; temperature range I, II											
Displacement	δ_{V0}	[mm/kN]	0,18	0,15	0,12	0,10	0,09	0,07	0,06	0,05	0,05
Displacement	$\delta_{V\infty}$	[mm/kN]	0,27	0,22	0,18	0,16	0,14	0,11	0,09	0,08	0,06

¹⁾ Calculation of the displacement for design load
 Displacement for short term load = $\delta_{V0} \cdot V_d / 1,4$
 Displacement for long term load = $\delta_{V\infty} \cdot V_d / 1,4$
 (V_d : design shear resistance)

Table C15: Displacements under tension load for fischer rebar anchors FRA ¹⁾

Size	Ø	12	16	20	24	
Un-cracked and cracked concrete; temperature range I, II						
Displacement	δ_{N0}	[mm/(N/mm ²)]	0,09	0,10	0,11	0,12
Displacement	$\delta_{N\infty}$	[mm/(N/mm ²)]	0,13	0,16	0,16	0,18

¹⁾ Calculation of the displacement for design load
 Displacement for short term load = $\delta_{N0} \cdot \tau_{sd} / 1,4$
 Displacement for long term load = $\delta_{N\infty} \cdot \tau_{sd} / 1,4$
 (τ_{sd} : design bond strength)

Table C16: Displacements under shear load for fischer rebar anchors FRA ¹⁾

Size	Ø	12	16	20	24	
Un-cracked and cracked concrete; temperature range I, II						
Displacement	δ_{V0}	[mm/kN]	0,12	0,09	0,07	0,06
Displacement	$\delta_{V\infty}$	[mm/kN]	0,18	0,14	0,11	0,09

¹⁾ Calculation of the displacement for design load
 Displacement for short term load = $\delta_{V0} \cdot V_d / 1,4$
 Displacement for long term load = $\delta_{V\infty} \cdot V_d / 1,4$
 (V_d : design shear resistance)

fischer injection system FIS EM

Performances
 Displacements reinforcing bars and fischer rebar anchor FRA

Annex C 14

Table C17A: Characteristic values of resistance for fischer threaded rods FIS A and RGM under seismic action performance category C1 in hammer drilled hole

Size			M8	M10	M12	M14	M16	M20	M22	M24	M27	M30	
Characteristic resistance tension load, steel failure													
N _{Rk,s,C1} [kN]	Zinc plated steel	Property class	5.8	-	29	43	58	79	123	152	177	230	281
			8.8	-	47	68	92	126	196	243	282	368	449
	Stainless steel A4 and steel C	Property class	50	-	29	43	58	79	123	152	177	230	281
			70	-	41	59	81	110	172	212	247	322	393
			80	-	47	68	92	126	196	243	282	368	449
γ _{M,s,C1} ¹⁾ [-]	Zinc plated steel	Property class	5.8	1,50									
			8.8	1,50									
	Stainless steel A4 and steel C	Property class	50	2,86									
			70	1,50 ²⁾ / 1,87									
			80	1,6									
Characteristic bond resistance, combined pullout and concrete cone failure													
(dry and wet concrete)													
Temperature range I ³⁾			τ _{Rk,C1}	[N/mm ²]	-	7,0	7,0	6,7	5,7	5,7	6,7	6,7	6,7
Temperature range II ³⁾			τ _{Rk,C1}	[N/mm ²]	-	7,0	7,0	6,7	5,7	5,7	6,7	6,7	6,7
(flooded hole)													
Temperature range I ³⁾			τ _{Rk,C1}	[N/mm ²]	-	7,5	7,5	6,5	6,5	5,7	6,7	5,7	5,7
Temperature range II ³⁾			τ _{Rk,C1}	[N/mm ²]	-	6,8	6,8	6,5	5,7	5,7	5,7	5,7	5,7
Characteristic resistance shear load, steel failure without lever arm													
V _{Rk,s,C1} [kN]	Zinc plated steel	Property class	5.8	-	15	21	29	39	61	76	89	115	141
			8.8	-	23	34	46	63	98	122	141	184	225
	Stainless steel A4 and steel C	Property class	50	-	15	21	29	39	61	76	89	115	141
			70	-	20	30	40	55	86	107	124	161	197
			80	-	23	34	46	63	98	122	141	184	225

¹⁾ For fischer threaded rods FIS A / RGM the factor for steel ductility is 1,0

²⁾ f_{uk} = 700 N/mm² ; f_{yk} = 560 N/mm²

³⁾ See Annex B 1

fischer injection system FIS EM

Performances
Design of bonded anchors
Seismic performances C1

Annex C 15

Table C17B: Characteristic values of resistance for standard threaded rods under seismic action performance category C1 in hammer drilled hole

Size			M8	M10	M12	M14	M16	M20	M22	M24	M27	M30	
Characteristic resistance tension load, steel failure													
Steel failure			See Table 17A										
Characteristic bond resistance, combined pullout and concrete cone failure			See Table 17A										
Characteristic resistance shear load, steel failure without lever arm													
$V_{Rk,s,C1}$	Zinc plated steel	Property class	5.8	-	11	15	20	27	43	53	62	81	99
			8.8	-	16	24	32	44	69	85	99	129	158
[kN]	Stainless steel A4 and steel C	Property class	50	-	11	15	20	27	43	53	62	81	99
			70	-	14	21	28	39	60	75	87	113	138
			80	-	16	24	32	44	69	85	99	129	158

fischer injection system FIS EM

Performances
Design of bonded anchors
Seismic performances C1

Annex C 16

Table C18: Characteristic values of resistance for reinforcing bars under seismic action performance category C1 in hammer drilled hole

Reinforcing bar	size	8	10	12	14	16	18	20	22	24	
Characteristic resistance tension load, steel failure											
$N_{Rk,s,C1}$	[kN]	-	44	63	85	111	140	173	209	249	
Characteristic bond resistance, combined pullout and concrete cone failure											
(dry and wet concrete)											
Temperature range I ¹⁾	$\tau_{Rk,C1}$	[N/mm ²]	-	7,0	7,0	6,7	5,7	5,7	5,7	6,7	6,7
Temperature range II ¹⁾	$\tau_{Rk,C1}$	[N/mm ²]	-	7,0	7,0	6,7	5,7	5,7	5,7	6,7	6,7
(flooded hole)											
Temperature range I ¹⁾	$\tau_{Rk,C1}$	[N/mm ²]	-	7,5	7,0	6,5	5,7	5,7	5,7	6,7	5,7
Temperature range II ¹⁾	$\tau_{Rk,C1}$	[N/mm ²]	-	6,8	6,8	5,8	5,8	5,7	5,7	5,7	5,7
Characteristic resistance shear load, steel failure without lever arm											
$V_{Rk,s,C1}$	[kN]	-	15	22	30	39	49	61	74	88	
Characteristic resistance tension load, steel failure											
$N_{Rk,s,C1}$	[kN]	270	292	339	389	443	-	-	-	-	
Characteristic bond resistance, combined pullout and concrete cone failure											
(dry and wet concrete)											
Temperature range I ¹⁾	$\tau_{Rk,s,C1}$	[N/mm ²]	6,7	6,7	6,7	6,7	4,8	-	-	-	-
Temperature range II ¹⁾	$\tau_{Rk,s,C1}$	[N/mm ²]	6,7	6,7	6,7	6,7	4,8	-	-	-	-
(flooded hole)											
Temperature range I ¹⁾	$\tau_{Rk,s,C1}$	[N/mm ²]	5,7	5,7	5,7	5,7	5,7	-	-	-	-
Temperature range II ¹⁾	$\tau_{Rk,s,C1}$	[N/mm ²]	5,7	5,7	5,7	5,7	4,8	-	-	-	-
Characteristic resistance shear load, steel failure without lever arm											
$V_{Rk,s,C1}$	[kN]	95	102	119	137	155	-	-	-	-	

¹⁾ See Annex B 1

fischer injection system FIS EM

Performances
Design of bonded anchors
Seismic performances C1

Annex C 17

Table C19: Characteristic values of resistance for fischer threaded rods FIS A, RGM and standard threaded rods under seismic action performance category C2 in hammer drilled hole

Size				M8	M10	M12	M14	M16	M20	M22	M24	M27	M30
Characteristic resistance tension load, steel failure													
$N_{Rk,s, C2}$	Zinc plated steel	Property class	5.8	-	-	39	--	72	108	-	177	-	-
			8.8	-	-	61	-	116	173	-	282	-	-
[kN]	Stainless steel A4 and steel C	Property class	50	-	-	39	-	72	108	-	177	-	-
			70	-	-	53	-	101	152	-	247	-	-
			80	-	-	61	-	116	173	-	282	-	-
Characteristic bond resistance, combined pullout and concrete cone failure (dry and wet concrete)													
Temperature range I ¹⁾		$\tau_{Rk, C2}$	[N/mm ²]	-	-	2,2	-	3,5	1,8	-	2,4	-	-
Temperature range II ¹⁾		$\tau_{Rk, C2}$	[N/mm ²]	-	-	2,2	-	3,5	1,8	-	2,4	-	-
Characteristic bond resistance, combined pullout and concrete cone failure (flooded hole)													
Temperature range I ¹⁾		$\tau_{Rk, C2}$	[N/mm ²]	-	-	2,3	-	3,5	1,8	-	2,1	-	-
Temperature range II ¹⁾		$\tau_{Rk, C2}$	[N/mm ²]	-	-	2,3	-	3,5	1,8	-	2,1	-	-
		$\delta_{N,(DLS)}$ ³⁾	[mm/(N/mm ²)]	-	-	0,09	-	0,10	0,11	-	0,12	-	-
		$\delta_{N,(ULS)}$ ³⁾	[mm/(N/mm ²)]	-	-	0,15	-	0,17	0,17	-	0,18	-	-
Characteristic resistance shear load, steel failure without lever arm													
$V_{Rk,s, C2}$ ²⁾	Zinc plated steel	Property class	5.8	-	-	14	-	27	43	-	62	-	-
			8.8	-	-	22	-	44	69	-	99	-	-
[kN]	Stainless steel A4 and steel C	Property class	50	-	-	14	-	27	43	-	62	-	-
			70	-	-	20	-	39	60	-	87	-	-
			80	-	-	22	-	44	69	-	99	-	-
		$\delta_{V,(DLS)}$ ⁴⁾	[mm/kN]	-	-	0,18	-	0,10	0,07	-	0,06	-	-
		$\delta_{V,(ULS)}$ ⁴⁾	[mm/kN]	-	-	0,25	-	0,14	0,11	-	0,09	-	-

¹⁾ See Annex B 1

²⁾ For fischer threaded rods FIS A / RGM the factor for steel ductility is 1,0

³⁾ Calculation for displacement

$$\delta_{N0} = \delta_{N0\text{-Faktor}} \cdot \tau;$$

$$\delta_{N\infty} = \delta_{N\infty\text{-Faktor}} \cdot \tau;$$

⁴⁾ Calculation for displacement

$$\delta_{V0} = \delta_{V0\text{-Faktor}} \cdot V;$$

$$\delta_{V\infty} = \delta_{V\infty\text{-Faktor}} \cdot V;$$

fischer injection system FIS EM

Performances

Design of bonded anchors
Seismic performances C2

Annex C 18